

ATARI® MEGAFILE™ Hard Disk Drive

For all Atari® MEGA™ and ST™ computers

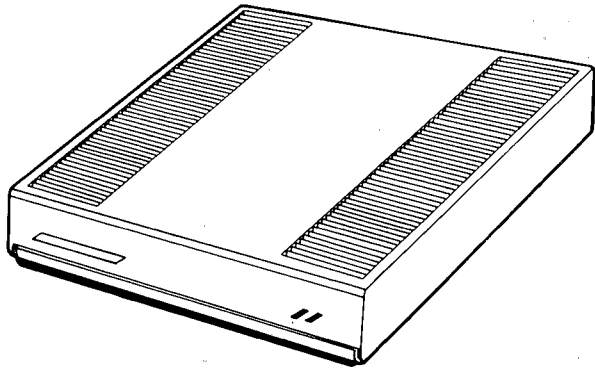

Owner's Manual

IMPORTANT INFORMATION

Like any electrical appliance, the Atari MEGAFILE hard disk drive uses and produces radio-frequency energy. If not installed and used according to the instructions in this manual, the equipment may cause interference with your radio and/or television reception.

If you believe that this equipment is causing interference, try switching it on and off. If the interference problem stops when the equipment is switched off, then the equipment is probably causing the problem. With the equipment switched on, you may be able to correct the problem by trying one or more of the following measures:

- Adjust the position of the radio or television antenna.
- Reposition the equipment in relation to the radio or television set.
- Plug the equipment into a different wall outlet so that the equipment and the radio or television set are connected to different branch circuits.

If necessary, consult your Atari computer retailer or an experienced radio-television technician for additional suggestions.

A resource that you may find helpful is a booklet prepared by the Federal Communications Commission (FCC): *Interference Handbook*. This booklet is available from the U.S. Government Printing Office, Washington, D.C. 20402, Stock No. 004-000-00450-7.

WARNING: This equipment has been certified to comply with the limits of a Class B computing device, pursuant to Subpart J of Part 15 of the FCC rules. These rules are designed to provide reasonable protection against such interference when the equipment is used in a residential setting. However, there is no guarantee that interference will not occur in a particular home or residence. Only the computing devices that have been certified to comply with the Class B limits may be attached to this equipment. Operation of noncertified devices with this equipment is likely to result in interference with radio and television reception. Shielded cables must be used on all I/O connectors; otherwise, radio emission may exceed Class B limits.

PLEASE NOTE: Every effort has been made to ensure the accuracy of the product documentation in this manual. However, because Atari Corporation is constantly improving and updating its computer hardware and software, it is unable to guarantee the accuracy of printed material after the date of publication and disclaims liability for changes, errors, or omissions.

Atari®, the Atari logo, CDAR504™, MEGA™, MEGAFILE™, MEGAFILE 20™, MEGAFILE 30™, MEGAFILE 60™, SH™, SH104™, SH204™, SH205™, SLM804™, and ST™ are trademarks or registered trademarks of Atari Corporation. GEM® and GEM® Desktop™ are trademarks or registered trademarks of Digital Research, Inc.

Reproduction of all or any portions of this manual is not allowed without the specific written consent of Atari Corporation.



Copyright © 1988, Atari Corporation
Sunnyvale, CA 94086
All rights reserved.

TABLE OF CONTENTS

INTRODUCTION	1
Using This Manual	1
CHAPTER 1: GETTING STARTED	3
Connecting One MEGAFILE.....	3
Connecting More Than One MEGAFILE.....	5
Switching the Hard Disk On and Off.....	7
The Atari Hard Disk Utilities.....	7
HDX Folder.....	8
HINSTALL Folder.....	8
AUTO Folder.....	9
Making a Working Copy of the Utilities Disk.....	9
CHAPTER 2: PREPARING A HARD DISK	11
Preparation Guidelines.....	11
Running the HDX Program.....	12
Formatting	14
Partitioning	17
Selecting a Unit to Partition.....	18
Selecting a Partitioning Scheme	19
Installing Logical Drives.....	21
CHAPTER 3: BOOTING YOUR SYSTEM WITH A HARD DISK	25
Booting From a Hard Disk	25
Installing the Hard Disk Driver	25
Booting the System	27
Booting From a Floppy Disk.....	28
Removing the Hard Disk Driver.....	28
Bypassing the Hard Disk Driver	28

CHAPTER 4: WORKING WITH AND MAINTAINING YOUR HARD DISK	29
Organizing Your Hard Disk.....	29
Extending the Folder Limit.....	29
Backing Up Data.....	30
Parking and Unparking the Drive Heads.....	31
Parking the Drive Heads.....	31
Unparking the Drive Heads.....	34
Marking Bad Sectors.....	34
Erasing the Contents of a Logical Drive.....	39
APPENDIX A: TROUBLESHOOTING AND PREVENTIVE MAINTENANCE	43
APPENDIX B: ERROR MESSAGES	47
APPENDIX C: MEGAFILE SPECIFICATIONS	53
APPENDIX D: POWER CONNECTION IN THE UNITED KINGDOM	55
GLOSSARY	57
CUSTOMER SUPPORT	61
INDEX	63

INTRODUCTION

The Atari MEGAFILE hard disk drive is a convenient, reliable data storage device for your Atari MEGA or ST computer. The Atari MEGAFILE offers ample storage capacity, powerful performance, easy installation, and an attractive design that stacks neatly on top of your MEGA computer.

The Atari MEGAFILE hard disk comes with a set of programs for preparing, operating, and maintaining this drive or an SH hard disk drive. These easy-to-use programs, called utilities, have been specially designed to help you get top performance from your hard disk.

If you're working with the Atari hard disk utilities for the first time, you'll appreciate the informative dialog and alert boxes that guide you every step of the way.

If you've used previous versions of the Atari hard disk utilities, you'll appreciate the enhancements in this new version. The HDX Format option now automatically marks and logs bad sectors on the entire physical hard disk. To mark bad sectors on individual logical drives (without erasing the entire partition), you use the HDX Markbad option. Also, the new version of HINSTALL installs the SHDRIVER.SYS file and has an option for removing the hard disk driver file.

Using This Manual

This manual describes how to connect the Atari MEGAFILE hard disk drive and use the Atari hard disk utilities to prepare and work with this drive or an SH hard disk drive. The chapters and sections are organized so you can easily find the information you need.

Chapter 1: Getting Started explains how to connect one or more MEGAFILE hard disk drives to your computer and get your system up and running. The chapter also describes the folders and files on the Atari Hard Disk Utilities disk and how they are used.

Chapter 2: Preparing a Hard Disk explains when and how to format the hard disk, partition it into logical drives, and install the logical drives from GEM Desktop.

Chapter 3: Booting Your System with a Hard Disk explains procedures for booting from the hard disk or a floppy disk.

Chapter 4: Working with and Maintaining Your Hard Disk explains how to organize data on your hard disk, extend the system-wide folder limit, back up your data, park the disk heads, mark bad sectors, and erase the contents of a logical drive.

Appendix A: Troubleshooting and Preventive Maintenance lists problems that may occur while setting up or operating your drive, and offers solutions. The appendix also includes helpful hints for proper maintenance of your hard disk drive.

Appendix B: Error Messages lists error messages you may see when running the Atari hard disk utilities and suggests solutions.

Appendix C: MEGAFILE Specifications lists the features and operating requirements of the MEGAFILE hard disk drive.

Appendix D: Power Connection in the United Kingdom provides additional setup instructions for MEGAFILE owners in the United Kingdom.

The **Glossary** defines common technical terms used in this manual.

Customer Support tells you where to find more information about the Atari hard disk utilities and all Atari computer products.

The **Index** helps you locate terms and procedures used or explained in the manual.

Paragraphs marked **Note** or **Warning** appear throughout the manual. Notes contain useful hints and other information relevant to the topic being discussed. Warnings alert you to potential problems and suggest ways to avoid them.

CHAPTER 1

GETTING STARTED

Your MEGAFILE hard disk drive, along with your entire Atari computer system, should be set up on a sturdy, level surface protected from dust, grease, extreme temperatures, direct sunlight, and high humidity. Be sure to provide room for adequate air flow around all system components.

Carefully unpack the Atari MEGAFILE and gently place it on a sturdy, level surface in the workspace you've chosen. Remove the packing materials and save them for storing or shipping your system later.

Your Atari MEGAFILE shipping carton should contain all of these items:

- Atari MEGAFILE hard disk drive
- Interface cable
- Power cable
- Atari Hard Disk Utilities disk
- This manual
- Warranty card

Check the items you received. If something is missing, contact your Atari dealer.

Connecting One MEGAFILE

If you have an Atari MEGA computer, you can stack the computer on top of the MEGAFILE, then place your monitor on top of the computer. If you have an ST computer, you can place the hard disk drive behind the computer and place the monitor on top of the hard disk.

To connect one MEGAFILE hard disk drive to your computer, follow these steps.

1. Make sure both the drive and computer are switched off.
2. Plug one end of the drive's interface cable into the port marked "Hard Disk" on the back of the computer. Plug the other end into the port marked "Hard Disk In" on the back of the drive. Secure the connection on both cable ends.
3. Plug one end of the power cable into the power jack on the back of the drive, then plug the power cable's electrical plug into a grounded electrical outlet. (Atari MEGAFILE owners living in the United Kingdom should see **Appendix D** for additional setup instructions.)

Connecting One Hard Disk Drive

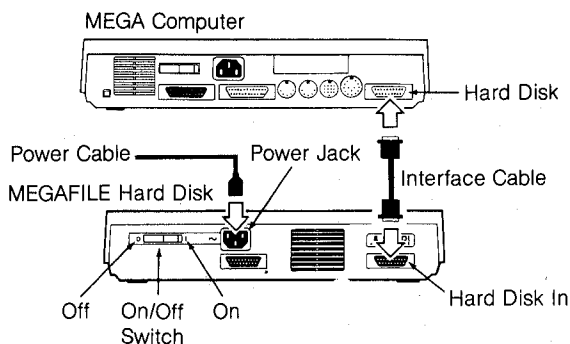

Warning: Do not slide papers or other material between the drive and the computer stacked on top of it. Doing so obstructs the air vents and prevents airflow to and from the drive's internal cooling system.

Connecting More Than One MEGAFILE

You can connect (or chain) up to four MEGAFILE hard disk drives (or other DMA devices, such as the Atari SLM804 laser printer or Atari CDAR504) to your system. (You can connect up to eight devices, but a total of no more than four is recommended.) Each device must have a unique unit number determined by the device's DIP switches. Since all MEGAFILE hard disk drives are set at the factory to be unit 0, the DIP switches in additional hard disk drives must be changed in order to work with your system. Take your drive to an authorized Atari service center to have these switches reset.

Warning: Do not attempt to open the hard disk or change the DIP switches yourself. If you do, Atari Corporation reserves the right to disclaim warranty liability for your MEGAFILE or any other adversely affected component in your system.

Once the DIP switches are correctly set, you can connect additional MEGAFILE hard disk drives by following these steps:

1. Make sure both the drive and computer are switched off.
2. Plug the interface cable into the port marked "Hard Disk In" on the back of the second drive. Then plug the cable's other end into the port marked "Hard Disk Out" on the back of the first drive (the drive connected directly to the computer). For each additional drive, connect an interface cable from Hard Disk Out to Hard Disk In on the next drive until all drives are connected.

3. For each MEGAFILE, plug one end of the power cable into the power jack on the back of the drive, then plug the power cable's electrical plug into a grounded electrical outlet. (Atari MEGAFILE owners living in the United Kingdom should see **Appendix D** for additional setup instructions.)

Connecting Additional Hard Disk Drives

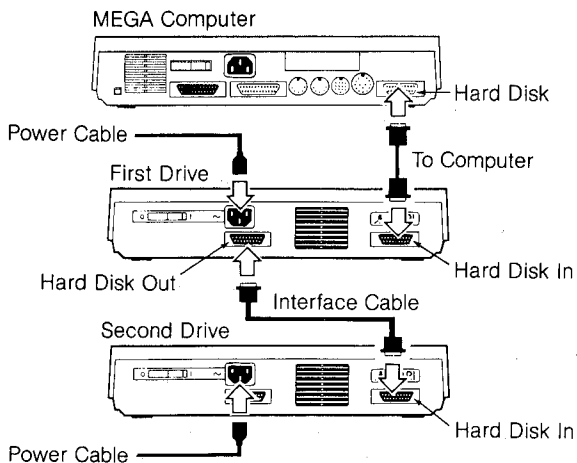

Note: You can also connect both a MEGAFILE and an Atari SH204 hard disk drive to your system. If you do, the SH204 must be connected as the last drive on the chain. See the owner's manual supplied with your SH204 hard disk drive for instructions on resetting the DIP switches in this drive.

Switching the Hard Disk On and Off

Always switch on the power to your hard disk(s) before switching on the power to your computer. During initialization, the busy light on the front of the drive should blink briefly and you should be able to hear the drive whir up to speed. When the light goes off and the whirring stops, switch on the power to your other peripherals, then switch on the power to your computer.

When you are ready to stop using your hard disk, switch the computer off first, then your hard disk and other peripherals. (If you are planning to move your hard disk, you need to park the hard disk drive heads. See **Parking the Drive Heads** in **Chapter 4**.)

The Atari Hard Disk Utilities

Once your hard disk drive is connected to the computer, you are ready to use the Atari Hard Disk Utilities disk. This disk contains programs and other files that allow your computer to work with either the MEGAFILE or an SH hard disk. Before you begin using these programs, you should have a good working knowledge of your Atari MEGA or ST computer system. Refer to your computer's owner manual for complete instructions.

Boot your system from the Atari Hard Disk Utilities disk, and display a directory window of that disk.

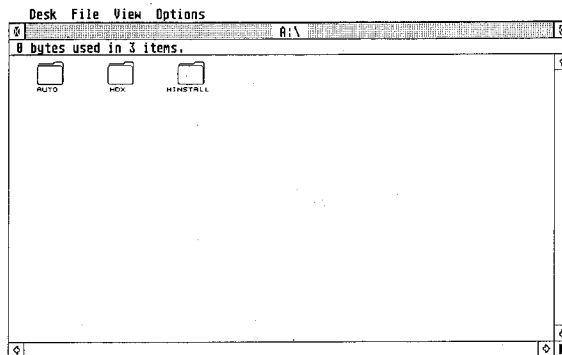

The following information briefly explains the folders and files contained on the utilities disk. The chapters that follow explain how to use these utilities to work with your hard disk.

HDX FOLDER

The HDX folder contains the files that prepare a hard disk to store data.

- **HDX.PRG** formats, partitions, zeros a logical drive, marks bad sectors, and parks the disk heads.
- **HDX.RSC** is a GEM resource file used by HDX.PRG.
- **SHIP.PRG** parks the heads on all system hard disks.
- **WINCAP** is a text file that includes the hard disk parameters used by HDX.PRG.

HINSTALL FOLDER

The HINSTALL folder contains files used for installing or removing the hard disk driver files.

- **HINSTALL.PRG** installs or removes the hard disk driver file.
- **HINSTALL.RSC** is a GEM resource file used by HINSTALL.PRG.
- **SHDRIVER.RAW** is used with HINSTALL.PRG to create SHDRIVER.SYS, the hard disk driver file that directs your system to boot from the hard disk.
- **COLDBOOT.PRG** allows you to perform a cold boot of your system without switching off the power to your system.

AUTO FOLDER

The AUTO folder contains several important programs that are read during system initialization.

- **AHDI.PRG** is a hard disk driver file that must be in the AUTO folder when booting from a floppy disk with a hard disk installed. AHDI.PRG makes it possible for your system to recognize the hard disk and display hard disk icon C.
- **FOLDR100.PRG** lets you extend the system-wide folder limit to a number you want.

Making a Working Copy of the Utilities Disk

It is essential that you make a backup, working copy of the Atari Hard Disk Utilities disk before beginning to work with it. A backup copy protects you from losing the original disk or damaging its contents. See your computer owner's manual for instructions on making a backup.

Always use the backup copy as your working disk. Store the original disk in a safe place protected from dust, moisture, direct sunlight, and sources of electrical power or magnetism.

CHAPTER 2 PREPARING A HARD DISK

Preparation Guidelines

Most of your hard disk preparation (formatting and partitioning) has already been done for you at the factory. All you need to do in order to begin storing data on your hard disk drive is install the logical drives as described in **Installing Logical Drives** in this chapter. The default partition sizes (sized for standard data storage needs) set after formatting are shown below in the **Default Partition Sizes Table**.

DEFAULT PARTITION SIZES TABLE

Atari Hard Disk	Default Partition Sizes in Megabytes
SH104	10
SH204, SH205, and MEGAFILE 20	4-6-10
MEGAFILE 30	10-10-10
MEGAFILE 60	15-15-15-15

Depending on what you want to do, you may not need to perform all the operations described in this chapter. Look over the **Hard Disk Preparation Table** to find the sections with the instructions you need. Read each section in the order listed.

HARD DISK PREPARATION TABLE

If You Want To...	Read These Sections
Use the factory-set partitions	Installing Logical Drives
Change the factory-set partitions	Running the HDX Program Partitioning Installing Logical Drives
Reformat the hard disk	Running the HDX Program Formatting Partitioning (only if you want to change the default partition sizes) Installing Logical Drives

Note: Formatting the hard disk is necessary only if the factory format becomes erased due to mishandling or if the hard disk develops bad sectors. See **Marking Bad Sectors** in **Chapter 4** and **Appendix A** for more information.

Running the HDX Program

The HDX program has the options you use to format and partition your hard disk.

Warning: The HDX Format and Partition options described in this chapter completely erase all data on your hard disk. If necessary, back up all valued files before proceeding.

Follow these steps to start the HDX program.

1. Make sure both the hard disk drive and computer are switched off.
2. Switch on the hard disk. The power and activity lights on the front panel light up as the drive initializes. After a few seconds, initialization is completed and the drive's activity light goes off.

3. Insert a working copy of the Atari Hard Disk Utilities disk into drive A and switch on the computer. When the system finishes initialization, GEM Desktop appears with hard disk icon C, as well as floppy disk icons A and B. (The AHDI.PRG program in the AUTO folder allows the system to recognize the hard disk.)

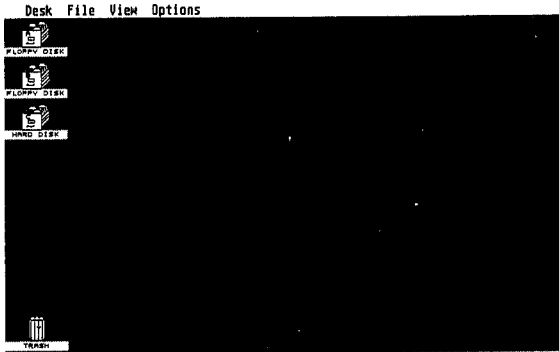

4. Display a directory of the HDX folder on disk A and select HDX.PRG. The HDX menu bar contains three headings (Desk, File, and Disk), and each heading has a drop-down menu of program options.

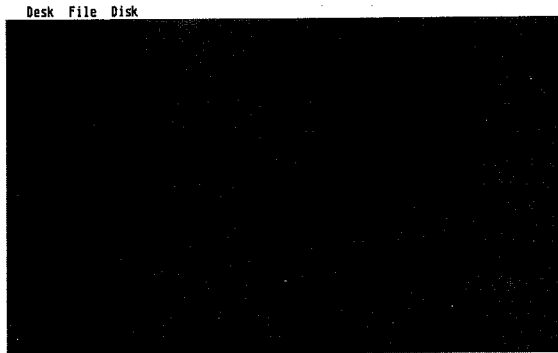

Formatting

Formatting the hard disk creates magnetic patterns called tracks and sectors, marks and logs bad sectors to be avoided during your hard disk operations, and divides the hard disk into storage areas called partitions or logical drives.

Follow these instructions to format a drive.

1. Display a directory of a working copy of the Atari Hard Disk Utilities disk and select HDX.PRG from the HDX folder. Then select the Format option from the Disk menu to run the HDX program.

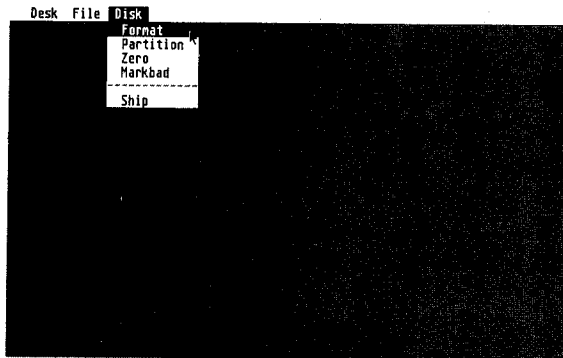

2. Read the alert message that appears on screen.

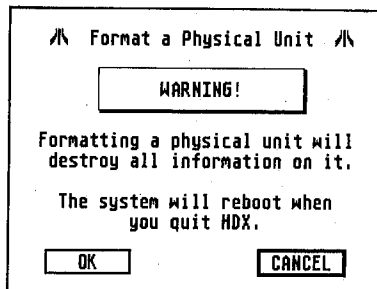

If necessary, back up all valued data on the disk before proceeding. If you have valued data in RAM, back it up also.

Select OK to continue.

3. Select a physical unit (hard disk drive) for formatting. If you are formatting the first or only hard disk on your system, or if you are formatting a drive that has never been formatted, select UNIT 0. (An unformatted drive must have its DIP switches set for unit 0.) If you are formatting an additional hard disk, select a unit that corresponds to the hard disk's DIP switch settings. (See **Connecting More Than One MEGAFILE** in **Chapter 1** for information about DIP switch settings.) Units in shadowed boxes have already been formatted.

Select the physical unit			
UNIT 0	UNIT 1	UNIT 2	UNIT 3
UNIT 4	UNIT 5	UNIT 6	UNIT 7
OK	CANCEL		

Select OK to continue.

4. Select a hard disk type by selecting the box that shows your drive's model name.

Select the unit type:

MEGAFILE 60	MEGAFILE 30	MEGAFILE 20
SH205	SH204	SH104

OK CANCEL

Select OK to continue.

5. Read the alert message that appears on screen.

⌘ Format a Physical Unit ⌘

LAST CHANCE TO QUIT!

Formatting unit 0
will erase everything
on it!

OK CANCEL

Select OK to format the unit.

During formatting, the hard disk is formatted, scanned for bad sectors, and divided into partitions. First, a message appears informing you that formatting is in progress. This is followed by the Physical Unit Markbad box. Markbad scans the hard disk cylinder by cylinder, displaying the number of previously marked bad sectors and keeping a tally of all the newly marked bad sectors. Finally, a message appears informing you that partitioning is in progress.

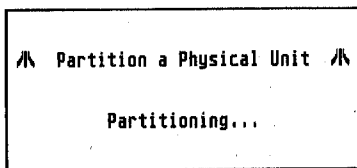

When the partitioning message disappears, the formatting operation is complete.

The number of partitions that are created and the size of each is determined by your Atari MEGAFILE or SH hard disk drive model and listed in the **Default Partition Sizes Table** at the beginning of this chapter.

Partitioning

Partitioning is the process of dividing your physical hard disk into data storage areas called logical drives. Each logical drive is used as a separate disk drive and assigned its own drive letter when you install the logical drives from GEM Desktop. Partitioning allows you to store and access your data efficiently.

Though formatting automatically creates partitions with default sizes, you can use the Partition option to create partitions in sizes best suited to your disk storage needs. The Partition option lets you use an editing menu to set the size of each partition or select a suggested partitioning scheme as explained in the next two sections.

SELECTING A UNIT TO PARTITION

1. Display a directory of a working copy of the Atari Hard Disk Utilities disk and select HDX.PRG from the HDX folder. Then select the Partition option from the Disk menu to run the HDX program.

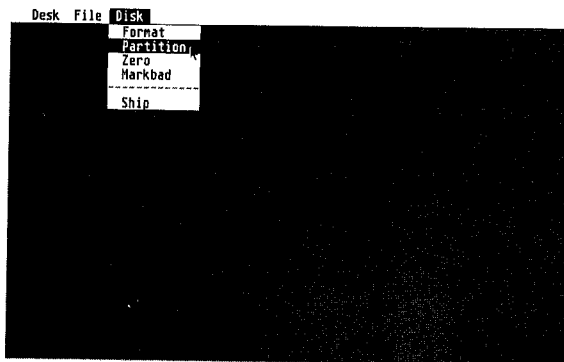

2. Read the alert message that appears on screen.

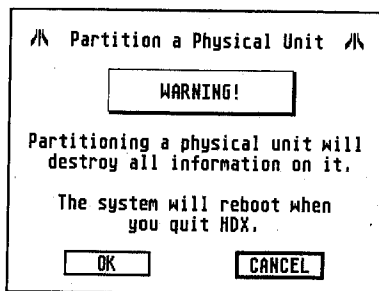

If necessary, back up all valued data on the disk before proceeding. If you have valued data in RAM, back it up also.

Select OK to continue.

3. Select a physical unit for partitioning. If you are partitioning the first or only hard disk on your system, select UNIT 0. If you are partitioning an additional hard disk, select a unit that corresponds to the hard disk's DIP switch settings. (See **Connecting More Than One MEGAFILE** in **Chapter 1** for information about DIP switch settings.) Only units in shadowed boxes can be selected.

Select the physical unit

UNIT 0	UNIT 1	UNIT 2	UNIT 3
UNIT 4	UNIT 5	UNIT 6	UNIT 7
OK		CANCEL	

Select OK to continue.

SELECTING A PARTITIONING SCHEME

After you select a physical unit for partitioning, you can then select a partitioning scheme with either the Edit Partition Scheme box or the Choose a Partition Scheme box.

The Edit Partition Scheme Box

The Edit Partition Scheme box appears after you select a physical unit for partitioning. This box displays the current partition sizes on the unit.

Dialog box titled "Edit partition scheme of the unit".

Left: 0Mb...

18.4Mb	↑	↓
18.4Mb	↑	↓
18.4Mb	↑	↓
Unused	↑	↓

Buttons: Menu, Undo, OK, CANCEL

Click on the up and down arrows to increase or decrease the size of the partitions in increments of 1 megabyte. Each partition can be no smaller than 1 megabyte and no larger than 16 megabytes.

To activate the partition labeled Unused, click on Unused and select a partition size by clicking on the up and down arrows. In order to activate an unused partition, 1 megabyte or more must appear in the Left box.

To return to the last original partition sizes, select Undo. Select OK when you are finished editing partition parameters.

The Choose a Partition Scheme Box

The Choose a Partition Scheme box appears when you select Menu from the Edit Partition Scheme box.

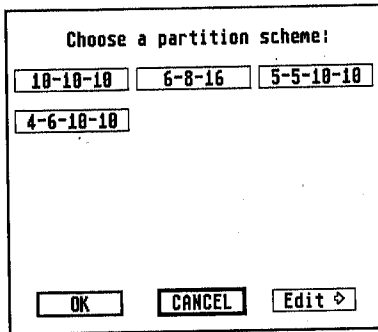

The Choose a Partition Scheme menu provides a list of suggested partitioning schemes. Select the scheme you want from the list. To return to the Edit Partition Scheme box, select Edit.

Once you've selected a partitioning scheme, select OK to partition the disk.

Installing Logical Drives

Logical drives are the partitions that were created during formatting or partitioning operations. In order to access any logical drive other than drive C, you must install logical drives from GEM Desktop.

Follow these steps to install logical drives.

1. Make sure your hard disk has been formatted and partitioned with the HDX program.

- From GEM Desktop, select the drive C icon, then select Install Disk Drive from the Options menu.

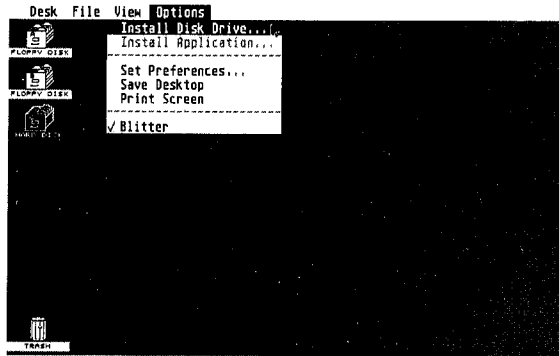

- When the Install Disk Drive dialog box appears, enter **D** as the new drive identifier by pressing **[Shift] [D]**. Then select Install to complete the installation of drive D.

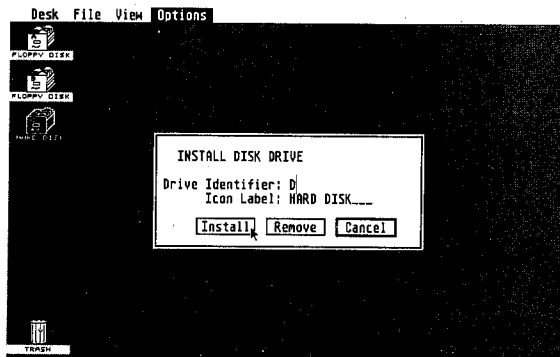

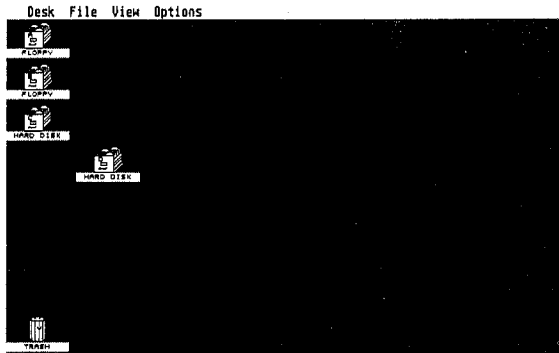

4. Repeat the procedure for each logical drive, identifying the logical drives in alphabetical order: the third partition becomes drive E; the fourth becomes drive F, and so on. A newly installed drive icon may cover a previously installed hard disk icon. Drag the newly installed hard disk icon to another area of the desktop to reveal the previously installed hard disk icon.
5. After you install all logical drives, choose a desktop configuration (and a screen resolution if you have a color monitor) and save it by selecting Save Desktop from the GEM Desktop Options menu. The desktop with all logical drives installed will be saved to the first partition on the drive unit. (See your computer owner's manual for more information on installing drives and saving the desktop.)

CHAPTER 3

BOOTING YOUR SYSTEM WITH A HARD DISK

With a hard disk installed, you can boot your system from either the hard disk or a floppy disk. Booting from the hard disk is the fastest way to start your system, but some programs (typically copy-protected programs and commercial games) require that you boot from a floppy disk.

Booting From a Hard Disk

INSTALLING THE HARD DISK DRIVER

In order to boot from the hard disk, you must run the HINSTALL program from the Atari Hard Disk Utilities disk. This program installs the hard disk driver file SHDRIVER.SYS in the root directory of the first partition on the active physical hard disk (typically the C partition on drive unit 0). When SHDRIVER.SYS is installed, your system automatically bypasses the floppy disk drive and boots directly from the hard disk. Do not remove SHDRIVER.SYS from the root directory; it must reside there in order for your system to boot from the hard disk.

To install the hard disk driver, follow these steps.

1. Make sure your hard disk is prepared as described in **Chapter 2**.
2. Display a directory of a working copy of the Atari Hard Disk Utilities disk and select HINSTALL.PRG from the HINSTALL folder.

3. When the HINSTALL menu bar appears, select Install from the File menu.

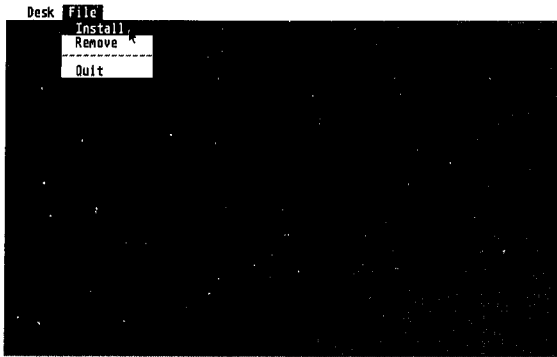

4. Select a physical unit (hard disk drive) for the operation. Only units in shadowed boxes can be selected.

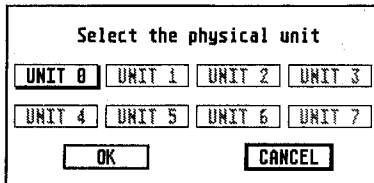

5. Read the alert box that appears on screen.

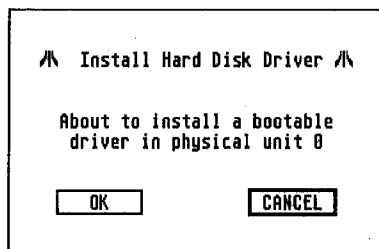

Select OK to continue.

BOOTING THE SYSTEM

After installing the hard disk driver with HINSTALL, you can boot your system from the hard disk by following these steps.

1. Switch off your system. To speed up the boot process, insert a blank, formatted floppy disk in floppy disk drive A.

Note: For instructions on how to format a floppy disk, see the owner's manual that came with your computer.

2. Switch on your monitor and the hard disk drive. When the drive's activity light goes off, switch on your computer. During the boot procedure, a message with the name, date, and version number of the hard disk driver file appears briefly before the desktop is displayed.

As an alternative to booting by switching the power off and on, you can also perform a cold boot of your system by selecting COLDBOOT.PRG from the HINSTALL folder. This program lets you completely initialize your system without touching the power switches. When you run this program (as with any cold boot), the contents of RAM will be lost.

Note: You can run COLDBOOT.PRG from either a floppy or hard disk.

Booting From a Floppy Disk

If you want to boot from a floppy disk (to start software that can boot from a floppy disk only), you can either remove the hard disk driver or bypass the driver by pressing **[Alternate]**. In order to work as a boot disk, the floppy disk must contain the AHDI.PRG file in the AUTO folder.

REMOVING THE HARD DISK DRIVER

To remove the hard disk driver, follow the steps in **Installing the Hard Disk Driver** in this chapter, but select Remove instead of Install from the HINSTALL menu.

BYPASSING THE HARD DISK DRIVER

As an alternative to removing the hard disk driver, you can simply bypass it. To do so, switch off your computer and make sure there is a floppy boot disk in drive A. Then switch on the system. When the floppy drive's busy light comes on, hold down **[Alternate]**. Release **[Alternate]** when the floppy drive's busy light stays on continuously.

You can also bypass the hard disk driver by running COLDBOOT.PRG, holding down **[Alternate]** when the floppy drive's busy light comes on, and releasing **[Alternate]** when the light stays on.

CHAPTER 4

WORKING WITH AND MAINTAINING YOUR HARD DISK

This chapter describes how to work with and maintain your hard disk. Following the procedures described in this chapter will help you get maximum benefit from your hard disk.

Organizing Your Hard Disk

The larger storage capacity of a hard disk means that careful folder and file organization is more important than ever. When planning and using your folder structure, keep the following tips in mind.

- Use folder names that describe the types of files in the folders. Keep files organized in folders so you can easily find them.
- Keep as few files as possible in the root directory. Normally, the only files you need in the root directory are your desk accessories.
- Keep the files you use most often in the first level of directories.
- Delete unneeded files to free disk space for new files.

Extending the Folder Limit

If you have a TOS release prior to 1988, your system allows you a total of 40 folders on all floppy and hard disks combined. You can extend this limit with FOLDR100.PRG. If you have a TOS release dated 1988 or later, the folder limit is automatically extended. Though most users will be able to create as many folders as they wish without problems, FOLDR100.PRG can still be used to extend the limit even further.

To use this program, copy FOLDR100.PRG from the AUTO folder on the Atari Hard Disk Utilities disk to the first partition on the boot hard disk (partition C if physical unit 0 is the boot disk). Then change the

100 in the filename to any value between 001 and 999 with the Show Info option on the GEM Desktop File menu. The value you enter is the number of folders beyond 40 you can now access. For example, to extend the limit to 240 folders, you would change the filename to FOLDR200.PRG.

You can further extend the folder limit by creating additional copies of FOLDR100.PRG. Each additional copy of the program has a unique name and represents a multiple of the number in the original copy of the program. For example, to extend the folder limit to 1240 (400 x 3 plus the original 40), you could enter

FOLDR400.PRG
AFOLDR.PRG
BFOLDR.PRG

All FOLDR programs must be stored in the AUTO folder of the boot disk (partition C on the hard disk if physical unit 0 is the boot disk).

The new folder limit takes effect when you reboot your system. During the boot procedure, a message appears that shows how many extra folders you've designated and how many bytes of RAM are allocated to the extra folders (each folder uses 132 bytes of RAM).

Backing Up Data

It's important to frequently back up your hard disk data. Otherwise, files that are accidentally deleted or damaged will be lost forever. As a general rule, it's good practice to back up new or modified files after each session at your computer.

To back up your data, regularly copy important files or folders onto floppy disks and store them in a safe place. In addition to the GEM copy option, you can use one of the many hard disk backup programs available through your Atari dealer or Atari user's group (see **Customer Support**).

Note: For information on copying files and folders, see the owner's manual that came with your computer.

Parking and Unparking the Drive Heads

PARKING THE DRIVE HEADS

Parking the hard disk drive heads protects your hard disk data when your hard disk is moved or shipped. The Atari hard disk utilities include two types of head parking programs.

Warning: Follow the instructions for parking drive heads exactly. If you fail to close all hard disk windows before parking the drive heads you may damage data on your hard disk.

To park the hard disk drive heads on all hard disks connected to your system, run SHIP.PRG. This program can be found in the HDX folder on the Atari Hard Disk Utilities disk.

Follow these instructions to run SHIP.PRG.

1. Insert a working copy of the Atari Hard Disk Utilities disk in a floppy drive and open the HDX folder. SHIP.PRG can be run from a floppy disk only.
2. Close all windows on all hard disk units.
3. Run SHIP.PRG and switch off your hard disk units as soon as GEM Desktop appears.

To park the heads on individual physical units, follow these instructions.

1. Insert a working copy of the Atari Hard Disk Utilities disk in a floppy drive, open the HDX folder, and start HDX.PRG. This operation can be run from a floppy disk only.

2. Select the Ship option on the Disk menu.

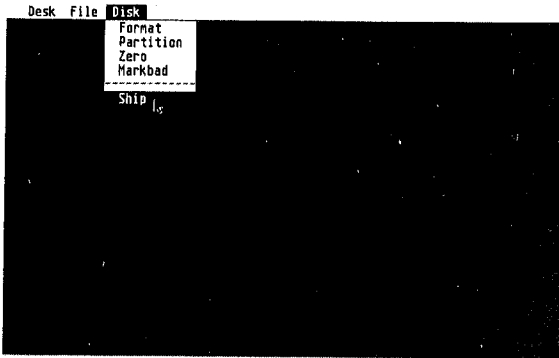

3. Read the alert box that appears on screen.

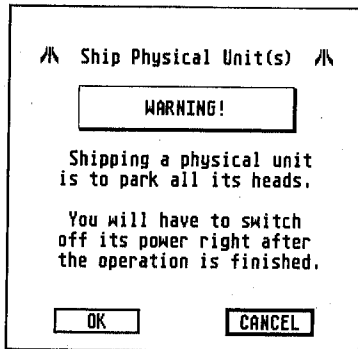

Select OK to continue.

4. When the Select physical unit(s) for operation dialog box appears, select the physical units that are to have their heads parked and select OK. In the following example, unit 0 is shadowed, indicating that it has been formatted.

Note: Any physical unit connected to your system (formatted or not) can be selected.

⌘ Ship Physical Unit(s) ⌘

Select the physical unit(s)

UNIT 0	UNIT 1	UNIT 2	UNIT 3
UNIT 4	UNIT 5	UNIT 6	UNIT 7

5. Read the alert box message that appears on screen.

⌘ Ship Physical Unit(s) ⌘

LAST CHANCE TO QUIT!

Shipping all physical units selected will require you to switch them off right after the operation is finished!

Select OK to park the heads.

6. Read the final alert box.

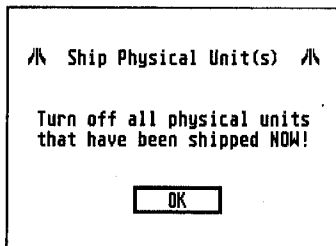

Select OK and switch off the power to your disk drive(s) as instructed in the alert box.

If you are preparing to move your entire system, you will also switch off your computer at this time.

UNPARKING THE DRIVE HEADS

The drive heads are automatically unparked when you switch on your hard disk the next time you start your system.

Marking Bad Sectors

Periodically, you should check your hard disk for bad sectors. This process identifies and flags defective areas on the hard disk. (It's normal for defective spots to develop after the drive has been used for a while.) Once these spots have been logged with Markbad, they will not be used for your hard disk operations.

The Atari hard disk utilities include two versions of Markbad. One version automatically operates on the entire selected physical unit when you run the HDX Format option. This version erases all data on the disk and should only be used if you don't want to save any files. The other version operates on the selected logical drive when you run the HDX Markbad option. This version helps you preserve data by letting you decide whether or not to erase data with bad sectors.

Both versions of Markbad report a log of any bad sectors found. The tally of bad sectors in the log appears during subsequent Markbad operations.

Note: You can use the HDX Markbad option on hard disks that have been formatted with a previous version of HDX.

To mark bad sectors on the entire physical drive, use the Format option as described in **Chapter 2**. To mark bad sectors in logical drives, follow these instructions.

1. Display a directory of a working copy of the Atari Hard Disk Utilities disk and select HDX.PRG from the HDX folder to run the HDX program. Then select the Markbad option from the Disk menu.

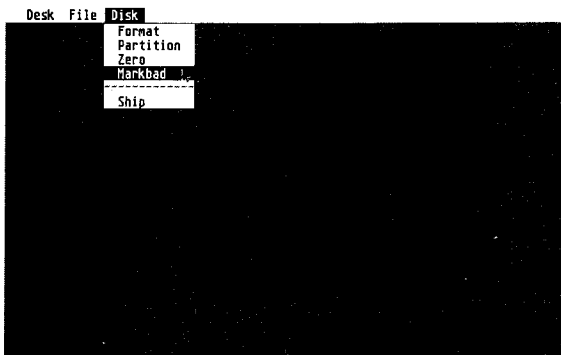

2. Read the alert box that appears on screen.

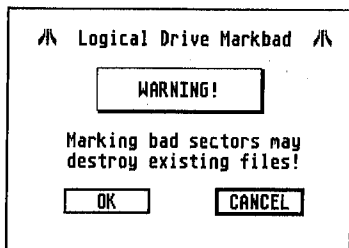

Select OK to continue.

3. Select a logical drive for the Markbad operation.

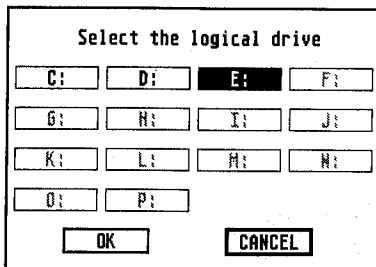

Select OK to continue.

4. While Markbad scans the logical drive for bad sectors, the following message appears.

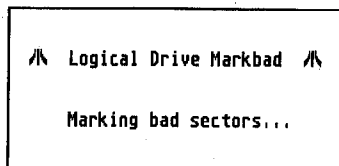

If bad sectors are found in a file, select a course of action for the file from the Logical Drive Markbad box. This box displays the name of the file, the address location of the bad sector and cluster in the logical drive, and your choices for a course of action.

Note: Markbad flags bad sectors in allocated clusters only.

```

  /  Logical Drive Markbad  \
  File
  E:\SAMPLE.DOC

  Bad sector: 627_
  Cluster: 266_

  Delete file
  Skip over bad sector
  Ignore bad sector

```

Select Delete File to erase the file or Skip Over Bad Sector to preserve the undamaged portions of the file. Select Ignore Bad Sector to leave the file unchanged. (Select Ignore Bad Sector if you want to examine the file before taking action.)

If bad sectors are found in a subdirectory file, select a course of action for the subdirectory from the Logical Drive Markbad box. This box displays the name of the subdirectory, its address location, and your choices for a course of action.

⌘ Logical Drive Markbad ⌘
Subdirectory E:\SAMPLDIR
Bad sector: 881_ Cluster: 353_
<input type="button" value="Delete directory only"/>
<input type="button" value="Delete directory and files"/>
<input type="button" value="Ignore bad sector"/>

Select Delete Directory Only to delete the directory structure and save the deleted directory files to the root directory. All files saved to the root directory will be named "TMPnnnn" where "nnnn" stands for the starting hexadecimal cluster address of the file. Select Delete Directory And Files to delete the directory structure and all of its files. Select Ignore Bad Sector if you don't want to take any action at all.

Saving files to the root directory of a full partition typically takes a few minutes.

Note: If a bad sector is found in a lost cluster, an alert box appears giving you the option of marking the cluster. A lost cluster is a segment of data that, for some reason, is unaccounted for and inaccessible to the user.

5. When Markbad is finished scanning the disk, a box with the total count of marked bad sectors and the count of all bad sectors appears.

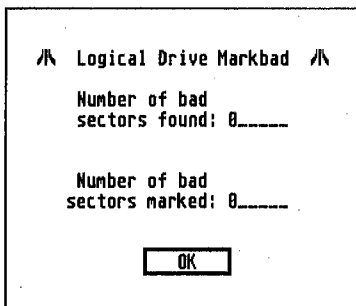

Select OK when you are finished looking at the tally box.

Erasing the Contents of a Logical Drive

You can erase all data from a selected logical drive with the Zero option of the HDX program on the Atari Hard Disk Utilities disk. Erasing (or zeroing) a logical drive is useful if you want to clear the drive to make room for new data or if you want to erase damaged data from a logical drive without reformatting (and thus erasing) the entire hard disk.

To zero the contents of a logical drive, follow these steps.

1. Display a directory of a working copy of the Atari Hard Disk Utilities disk and select HDX.PRG from the HDX folder to run the HDX program. Then select the Zero option from the Disk menu.

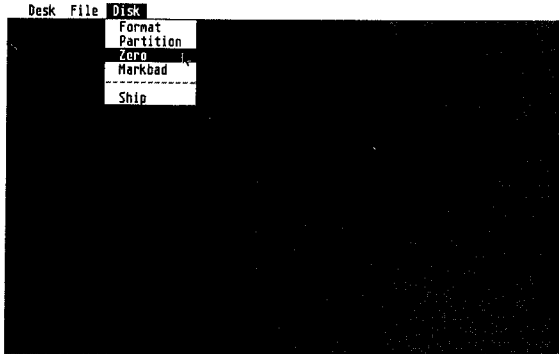

2. Read the alert box that appears on screen.

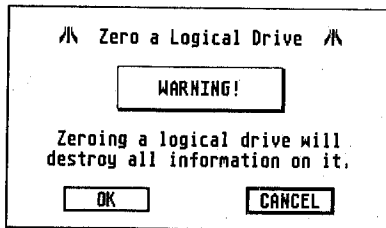

Select OK to continue.

3. Select a logical drive for zeroing.

Select the logical drive

C:	D:	E:	F:
G:	H:	I:	J:
K:	L:	M:	N:
O:	P:		

OK CANCEL

Select OK to continue.

4. An alert box appears giving you a final chance to quit the program before proceeding.

/\ Zero a Logical Drive /\

LAST CHANCE TO QUIT!

Zeroing drive E:
will erase everything
on it!

OK CANCEL

Select OK to continue.

The message "Zeroing . . ." appears during the zeroing operation.

```
⌘ Zero a Logical Drive ⌘  
  
Zeroing...
```

APPENDIX A TROUBLESHOOTING AND PREVENTIVE MAINTENANCE

Troubleshooting

The most common and easily fixed hard disk problem is a loose cable connection or failure to switch on the power to the disk drive. Always check these first before exploring other possibilities. One instance where this will be a problem is when you are using the HDX program. If the drive isn't properly connected, you will not be able to complete your HDX operation because the physical unit will not be shadowed and available for selection.

If you run into problems connecting or operating your MEGAFILE hard disk drive, check the following list for suggested solutions.

Problem	Suggested Solution
Power light does not come on.	Make sure the power cable is securely connected on both ends and the electrical outlet is working properly.
Drive doesn't whirl and busy light doesn't come on.	Make sure all hard disk cables are secure and the hard disk is switched on. If you are booting from a floppy disk, make sure you have a working floppy disk in drive A. If the problem persists, take the hard disk in for servicing.
Hard disk icon C does not appear when you switch on your system.	Make sure the hard disk is properly connected and switched on. If you are booting from a floppy drive, make sure the boot disk contains AHDI.PRG in the AUTO folder. If you are booting from the hard disk, you may need to back up your data (see Backing Up Data in Chapter 4) and reformat the drive (see Formatting in Chapter 2).

Problem	Suggested Solution
The system will not boot from the hard disk.	Run the hard disk driver installation program HINSTALL. If the problem continues, the hard disk should be backed up (see Backing Up Data in Chapter 4) and reformatted (see Formatting in Chapter 2).
An application program will not start from the hard disk.	The program contains garbled data or was not designed to start from a hard disk. Try booting from the floppy drive with a different copy of the program. If it still won't start from the hard disk, contact the program's manufacturer for more information.

If you still have problems, your hard disk may have developed unusable data. Try erasing individual bad files and replacing them with valid backups. If this isn't possible, follow these steps to try and recover data.

1. Run the Markbad option of the HDX program on the Atari Hard Disk Utilities disk (as described in **Marking Bad Sectors** in **Chapter 4**) in each logical drive containing unreadable data. Recover as much data as possible.
2. Back up the recovered data in the logical drive to floppy disks.
3. Erase all data in the problem logical drive(s) with the Zero option of the HDX program and run Markbad on it again.
4. Copy the data you backed up to the logical drive.

If the boot partition (drive C on physical unit 0) contains unreadable data, you may not be able to boot from the hard disk. Use a working copy of the Atari Hard Disk Utilities disk to boot the system and follow the steps above. To make the partition bootable again, install the hard disk driver as described in **Chapter 3**.

If necessary, turn to **Appendix B** for a list of error messages and suggested solutions.

If you experience operating problems you can't resolve, take the MEGAFILE to an authorized Atari service center. For the location of the nearest Atari service center, contact your Atari dealer or see **Customer Support** in this manual.

Preventive Maintenance

To ensure top performance from both your MEGAFILE and your entire Atari computer system, follow these guidelines.

- Set up your disk drive and system on a sturdy, level surface protected from dust, grease, extreme temperatures, direct sunlight, and moisture.
- Avoid smoking near your system and keep all liquids away from all components.
- Switch off your system before cleaning it. Clean only the outside of the components with a soft, slightly damp, lint-free cloth. Do not use cleansers, abrasives, or solvents.
- Before moving, shipping, or storing your hard disk drive, park the heads with the Ship option of the HDX program or SHIP.PRG (see **Parking the Drive Heads** in **Chapter 4**).
- Do not remove the drive's housing. If you do, you run the risk of electrocuting yourself and damaging the drive and the rest of your computer system.

APPENDIX B

ERROR MESSAGES

If an error message appears while you are running one of the Atari hard disk utility programs, it's usually something easily remedied. If you aren't sure what to do when an error message appears, read the message carefully for a suggested solution. If there is none, find the message in the alphabetical list below and try the solution suggested.

Error Message	Program and/or Option	Suggested Solution
Bad Sector List is corrupted! Try backing up the disk and reformatting it. [OK]	HDX Format Partition Zero Markbad	See message.
Cannot create driver file at destination! [OK]	HINSTALL Install	Your root directory may be full. You need to delete data to make room for the driver file. Or, your root directory may be corrupted. If so, back up as much data as you can and reformat the drive.
Cannot find format parameters for disk type <disk type name> [OK]	HDX	Make sure the original WINCAP file is on the disk with HDX.
Cannot find partition scheme <selected partition scheme> [OK]	HDX Partition	This partition scheme is not recognized by HDX. Make sure you are using your original WINCAP file. Warning: Do not modify the WINCAP file. Doing so may destroy the disk.

Error Message	Program and/or Option	Suggested Solution
Cannot format <selected unit>! Try checking all the connections and reformatting it. [OK]	HDX Format	Make sure your hard disk is securely connected as explained in Chapter 1 . Then reformat the drive.
Cannot open driver source file! [OK]	HINSTALL Install	Make sure the SHDRIVER.RAW file is on the disk with HINSTALL.PRG.
Cannot partition <selected unit>! Try reformatting it. [OK]	HDX Partition	See message.
Cannot read Bad Sector List from the disk! Try backing up the disk and reformatting it. [OK]	HDX Format Partition Zero Markbad	See message.
Cannot read Boot Sector from the logical drive! Try backing up the disk and reformatting it. [OK]	HDX Zero Markbad HINSTALL Install	See message.
Cannot read File Allocation Table from the logical drive! Try backing up the disk and reformatting it. [OK]	HDX Partition Zero Markbad	See message.
Cannot read from directory! Try re-running Markbad on this logical drive when the current Markbad is completed. [OK]	HDX Markbad	See message.
Cannot read Root Directory entries from the logical drive! Try backing up the disk and reformatting it. [OK]	HDX Markbad	See message.

Error Message	Program and/or Option	Suggested Solution
Cannot read Root Sector from the disk! Try backing up the disk and reformatting it. [OK]	HDX Partition HINSTALL Install Remove	See message.
Cannot save any more files in the root directory! Deleting the remaining lost clusters of the subdirectory will free up disk space [OK] [CANCEL]	HDX Markbad	When the Markbad option found a bad sector in a subdirectory, you directed the program to save the deleted directory's files to the root directory. Now there is no more room in the root directory for the files and you can either select OK to delete the rest of the directory's files or CANCEL if you are going to use a disk utility that can recover the directory's files.
Cannot write Bad Sector List to the disk! Try backing up the disk and reformatting it. [OK]	HDX Format Partition Zero Markbad	See message.
Cannot write Boot Sector to the logical drive! Try backing up the disk and reformatting it. [OK]	HDX ZERO HINSTALL	See message.
Cannot write driver file to destination! [OK]	HINSTALL Install	HINSTALL can't write to the root directory of the drive. Try backing up the hard disk and reformatting it.
Cannot write Header to the logical drive! Try backing up the disk and reformatting it. [OK]	HDX Zero	See message.

Error Message	Program and/or Option	Suggested Solution
Cannot write Root Directory entries to the logical drive! Try backing up the disk and reformatting it. [OK]	HDX Markbad	See message.
Cannot write Root Sector to the disk! Try backing up the disk and reformatting it. [OK]	HDX Format Partition HINSTALL Install Remove	See message.
Cannot write to directory! Try re-running Markbad on this logical drive when the current Markbad is completed. [OK]	HDX Markbad	See message.
Driver file does not exist! [OK]	HINSTALL Remove	The driver file SHDRIVER.SYS has not been installed or is missing.
File Allocation Table is corrupted! Try backing up the logical drive and zeroing it. [OK]	HDX Markbad	Back up the logical drive, erase its data with the HDX Zero option, run Markbad, and restore your data.
Format parameters in the root sector are corrupted! Please reformat the disk. [OK]	HDX Partition	See message.
? HDX.RSC [OK]	HDX	The HDX.RSC file is either missing or damaged. Copy the HDX.RSC file from the original Atari Hard Disk Utilities disk onto your working copy of the disk.
No menu items available for this disk's capacity. [OK]	HDX Partition	Use the Edit Partition Scheme box to set partition sizes.

Error Message	Program and/or Option	Suggested Solution
Not enough system memory! Cannot continue. [OK]	HDX HINSTALL	Your computer's memory capacity is too low to run these programs. You need a minimum of 512 kilobytes.
Partition <0, 1, 2, or 3> is too big! Repartition the disk. [OK]	HDX Partition	See message.
Reserved sectors are bad! Try backing up the disk and reformatting it. [OK]	HDX Format Partition	See message.
Selected partition scheme is for a bigger capacity unit. Please select another one. [OK]	HDX Partition	See message.
Too many bad sectors to record. Try backing up the disk and reformatting it. [OK]	HDX Markbad	See message.
Too many logical drives! You cannot have more than 14 logical drives. [OK]	HDX Format Partition	You cannot have more than 14 logical drives on your system. Repartition disks as necessary.
Unrecognized boot sector! Either this logical drive's boot sector is corrupted, or another utility was used to partition this disk. [OK]	HDX Zero Markbad	Before you can use Zero or Markbad, you must back up your hard disk (if necessary) and reformat with HDX Format.
WINCAP file not found! Cannot continue. [OK]	HDX	Copy the WINCAP file on the Atari Hard Disk Utilities disk to the disk from which you are running HDX.
Your system will have to reboot when you quit HDX, for new disk information to take effect. [OK]	HDX Format Markbad	No action required. Your system will reboot when you quit HDX so the disk parameters you changed can take effect. Any data in RAM will be lost.

APPENDIX C

MEGAFILE SPECIFICATIONS

Because Atari MEGAFILE hard disk drives may use parts from different manufacturers, individual drive specifications may vary. The list below is a summary of the standard MEGAFILE specifications.

	MEGAFILE 30	MEGAFILE 60
Formatted Storage Capacity	32,747,520 bytes	64,616,448 bytes
Disk Platters	2	3
Surfaces	4	6
Recording Heads	4	6
Cylinders	615	809
Number of Tracks	2460	4854
Track Density tracks per inch	588	753
Data Format	RLL	RLL
Data Transfer Speed megabits per second	7.5	7.5
Rotational Speed	3600 rpm \pm 1.0%	3600 rpm \pm 0.5%
Latency Time	8.33 ms	8.33 ms
Seek Time (average)	65 ms	61 ms
Power Supply	120V, 60 Hz (USA) 240V, 50 Hz (UK)	
Power Consumption	14.8 Watts	18.1 Watts

Ambient Temperature

Operating or Idle

50 to 122° F (10 to 50° C)

Storage

-40 to 135° F (-40 to 57° C)

Relative Humidity
(operating, idle, or storage)

8 to 80% noncondensing

Altitude (from sea level)

Operating

-200 to 10,000 ft. (-63 to 3,143 m)

Nonoperating

40,000 ft (12,572 m) maximum

Start Time

22 seconds (typically) from power up to ready

Stop Time

20 seconds from power down

Shock

Nonoperating

40 g

Operating

4 g

Dimensions

Height

2.75 in. (7 cm,

Width

13.4 in. (34 cm)

Depth

13.4 in. (34 cm)

Weight

9.4 lb. (4.27 kg)

Connector Pinouts

- 1 - Data 0
- 2 - Data 1
- 3 - Data 2
- 4 - Data 3
- 5 - Data 4
- 6 - Data 5
- 7 - Data 6
- 8 - Data 7
- 9 - Chip Select
- 10 - Interrupt Request
- 11 - Ground
- 12 - Reset

- 13 - Ground
- 14 - Acknowledge
- 15 - Ground
- 16 - A1
- 17 - Ground
- 18 - Read/Write
- 19 - Data Request

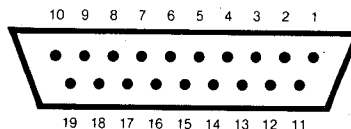

APPENDIX D

POWER CONNECTION IN THE UNITED KINGDOM

In the United Kingdom, the Atari MEGAFILE operates on ~240V, 50 Hz mains supply. The wires in the mains lead of the Atari MEGAFILE are colored as follows:

Wire	Color
Green/Yellow	Earth (E)
Blue	Neutral (N)
Brown	Live (L)

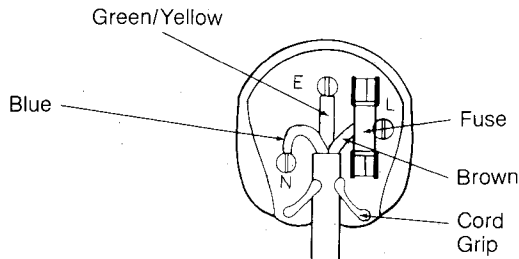

If the colors of the wires do not correspond to the colored markings identifying the terminals in your plug, proceed as follows:

Connect the GREEN/YELLOW wire to the terminal in the plug marked by the letter E or by the safety earth symbol \perp , or colored GREEN or GREEN/YELLOW. Connect the BLUE wire to the terminal marked with the letter N or colored BLACK. Connect the BROWN wire to the terminal marked with the letter L or colored RED.

If a 13-amp (BS1363) plug is used, a 3-amp fuse must be fitted, or if any other type of plug is used, a 3- or 5-amp fuse must be fitted either in the plug, adapter, or on the distribution board.

Mains Plug Adapter

The wires in the mains lead are colored in accordance with the following code:

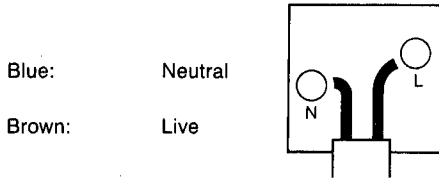

If the colors of the terminals in this device do not correspond with the colors of the terminals in your plug, proceed as follows:

The wire colored **BROWN** must be connected to the terminal marked with the letter **L** or colored **RED**.

The wire colored **BLUE** must be connected to the terminal marked with the letter **N** or colored **BLACK**.

If a 13-amp (BS1363) plug is used, a 5-amp fuse must be fitted. If any other type of plug is used, a 5-amp fuse must be fitted either in the plug, the adapter, or on the distribution board.

GLOSSARY

Atari Hard Disk Utilities A collection of programs for preparing, operating, and maintaining your Atari MEGAFILE or SH hard disk drive.

AUTO folder The folder on a hard or floppy disk that contains files that are read when your system boots from a floppy drive. In order to recognize the hard disk, this folder must contain AHDI.PRG on the floppy boot drive.

back up To make an archive copy of a disk, folder, or file. Backing up data ensures that data is not lost if a disk is accidentally damaged or erased.

bad sector list A log of the bad sectors flagged during Format and Markbad operations. Your hard disk automatically avoids saving data to the sectors in this log. (See **Markbad**.)

bad sectors Defects on the disk media that are unable to reliably store data.

boot disk The disk you use to boot the computer.

boot sector The logical drive sector that stores information about that drive.

cluster Two sectors of data. A cluster is the amount of data that can be added or subtracted from a file at one time. (See **sector**.)

cylinder Tracks of equal radius on all hard disk platters. (See **tracks**.)

error message An alert box message that indicates a condition that prevents the program from continuing.

File Allocation Table (FAT) A table that shows which clusters are allocated and which clusters are free on a drive. The File Allocation Table is created during partitioning.

folder limit The number of folders on all disks that your system can access. You can extend the limit with FOLDR100.PRG.

FOLDR100.PRG A program that lets you extend the number of folders you can have on your system (See **folder limit**.)

formatting The process of setting the patterns on a disk that enable it to store data.

hard disk driver The file that enables your system to boot from the hard disk. This file, SHDRIVER.SYS, is created when you run HINSTALL.

HDX.PRG The Atari hard disk utility program you use to prepare your hard disk. This program has options for formatting, partitioning, marking bad sectors, zeroing logical drives, and parking the drive heads.

HINSTALL The Atari hard disk utility that creates a hard disk driver. Creating a hard disk driver lets you boot from the hard disk. (See **hard disk driver**.)

logical drive The data storage areas set during partitioning. Each logical drive is used as a separate disk drive and assigned its own drive letter when you install the logical drives from GEM Desktop.

Markbad An operation that scans the disk for bad sectors and creates a log of bad sectors that will be avoided during your disk operations. Markbad operates on the entire disk when you format the disk and on individual logical drives when you select the Markbad option from the HDX Disk menu.

partitioning The process of dividing the hard disk into logical drives. Partitioning occurs automatically when you format the disk or when you select the Partition option from the HDX Disk menu.

partitioning scheme The storage capacity chosen for your logical drives. You can use the default partitioning scheme set during formatting or select your own partitioning scheme with the Partition option of the HDX Disk menu.

physical unit The entire hard disk drive. Each hard disk drive connected to your system is a physical unit.

root sector The sector of the hard disk that stores boot and partition information. If the root sector is missing or damaged, you will not be able to use your hard disk.

sector A portion of a track on the hard disk. A sector holds 512 bytes of data. (See **tracks**.)

SHIP.PRG An Atari hard disk utility program that parks the drive heads over an unused portion of the disk. Parking the drive heads protects your data when you move or ship your hard disk.

tracks Data storage areas consisting of concentric circles on the disk (similar to the tracks on a record). Tracks are set during formatting and are divided into sectors.

WINCAP A text file used by the HDX program. WINCAP contains disk parameter information needed to format and partition the hard disk.

zero To erase the entire contents of a logical drive. You zero a logical drive with the Zero option of the HDX program.

CUSTOMER SUPPORT

Atari Corporation welcomes inquiries about your Atari computer products. We also provide technical assistance. Write to **Customer Relations** at an address listed below.

Atari user groups also provide outstanding assistance. To receive a list of Atari user groups in your area, send a self-addressed, stamped envelope to an address below.

In the United States, write to:

Atari Corporation
Customer Relations
P. O. Box 61657
Sunnyvale, CA 94088

In Canada, write to:

Atari (Canada) Corp.
90 Gough Road
Markham, Ontario
Canada L3R 5V5

In the United Kingdom, write to:

Atari Corp. (UK) Ltd.
P. O. Box 555
Slough
Berkshire SL2 5BZ

Please indicate **User Group List**, **Technical Assistance**, or the subject of your letter on the outside of the envelope.

INDEX

A

activity light, 12, 27
AHDI.PRG (hard disk driver), 9, 13, 28
air vents, 4
alert message, 14, 16, 18, 27, 32, 36, 40, 41
[Alternate] key, 28
AUTO folder, 9, 13, 29, 30

B

backing up files, 8, 9, 15, 18
backing up hard disk data, 30
booting, 25-28
 from a floppy disk, 28
 from a hard disk, 25-27
busy light, 7, 28
bypassing the hard disk boot, 27, 28

C

CDAR504, 5
Choose a Partition Scheme box, 19, 21
cold boot, 8, 27
COLDBOOT.PRG, 8, 27
commercial games, 25
connecting (chaining)
 one MEGAFILE, 3-4
 more than one MEGAFILE, 5-6
cooling system, 4
copy-protected programs, 28
copying files, 30
copying the utilities disk, 9

D

default partition sizes, 11
desk accessories, 29
Desk menu, 13
DIP switches, 5, 6, 15
Disk menu, 13, 14, 18
drive A, floppy, 27, 28
drive C, hard disk, 22
drive D, hard disk, 22
drive E, hard disk, 23
drive F, hard disk, 23
drive identifier, 22

E

Edit Partition Scheme box, 19, 21, 22
erasing the contents of a logical drive, 39
erasing the hard disk, 39
error messages, App. B
extending the folder limit, 29-30

F

File menu (HDX.PRG), 13
floppy disk, 27, 28
folders, 29-30
 40-folder limit, 29
 extending the folder limit, 29-30
FOLDR100.PRG, 9, 29-30
Format option, 12, 14, 35
formatting, 11, 12, 14-17

G

GEM copy option, 30
GEM Desktop, 13, 17, 21, 22, 23, 30, 31

H

- hard disk driver, 8
 - bypassing, 28
 - installing, 25-27
 - removing, 28
- Hard Disk In port, 4, 5
- Hard Disk Out port, 5
- Hard Disk port, 4
- Hard Disk Utilities disk, 7-8, 9, 13, 29
- HDX.PRG, 8, 13, 14, 18, 31, 35, 40
 - loading, 12
 - menu bar, 13
- HDX.RSC, 8
- HINSTALL.PRG, 8, 25-26
 - menu bar, 26
- HINSTALL.RSC, 8

I

- icons, floppy disk, 13
- icons, hard disk, 9, 13, 23
- Ignore Bad Sector, 37, 38
- initialization, 7, 9, 13, 27
- installing the hard disk driver, 25-27
- installing logical drives, 21-23

L

- logical drive, 14, 17, 21
 - accessing from GEM Desktop, 21
 - erasing, 39
 - identifying, 23
 - installing, 21-23
 - marking bad sectors in, 35-39
 - zeroing, 39, 40-42

M

- main directory limit, hard disk, 29-30
- mains plug adapter, App. D
- Markbad option, 17, 34-39
- marking bad sectors, 8, 34-39
- MEGA computer, 3, 7
- MEGAFILE specifications, App. C
- menu bar
 - HDX.PRG, 13
 - HINSTALL.PRG, 26
- menus
 - Desk (HDX.PRG), 13
 - Disk (HDX.PRG), 13
 - File (HDX.PRG), 13
 - File (HINSTALL.PRG), 26
- model name, hard disk drive, 16
- monitor, 3

N

- naming files, 29

O

- operating problems, App. A
- organizing the hard disk, 29

P

- parking the disk heads, 8
- parking the drive heads, 31-34
- partition, 8, 12, 14, 17
 - parameters, 20
 - size, 20
- Partition option, 11, 12, 17, 18
- partitioning, 17-19
- physical unit, 15, 19, 26
- Physical Unit Markbad box, 17
- power connection in the United Kingdom, App. D
- power jack, 4, 6
- preventive maintenance, App. A

R

RAM, 15, 18, 27, 30
rebooting the system, 30
root directory, 29

S

saving the desktop, 23
sectors, 34-39
setting up the hard disk drive, 3
shadowed boxes, 19, 26
SHDRIVER.RAW, 8
SHDRIVER.SYS, 8, 25
Show Info option, 29-30
Ship option, 32
SHIP.PRG, 8, 31
SH204DVR.SYS, 6
SLM804 laser printer, 5
software problems, App. A
specifications, App. C
ST computer, 3, 7
storing disks, 9
switching on the system, 7, 12
system maintenance, App. A

T

TOS release
 prior to 1988, 29
 1988 or later, 29
troubleshooting, App. A
type, hard disk drive, 16

U

unpacking the hard disk drive, 3
unparking the drive heads, 34
utilities disk, 7-8, 9, 13, 29
 copying, 9

W

WINCAP, 8
windows, 7, 31

Z

Zero option, 39, 40
zeroing logical drives, 8, 39-42



Copyright © 1988, Atari Corporation
Sunnyvale, CA 94086
All rights reserved.



C300459-001 Rev. B
Printed in Taiwan.
K. I. 9. 1988